

ARMARIO SALA DIRETORIA

VISTA FRONTAL ABERTO

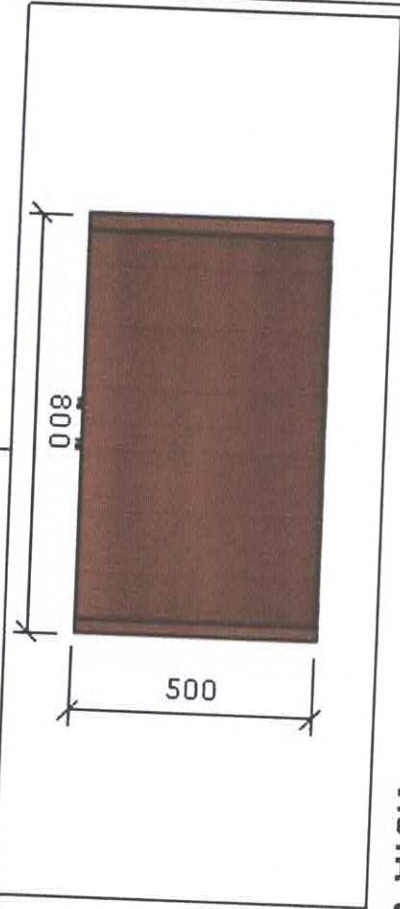

VISTA SUPERIOR



VISTA LATERAL

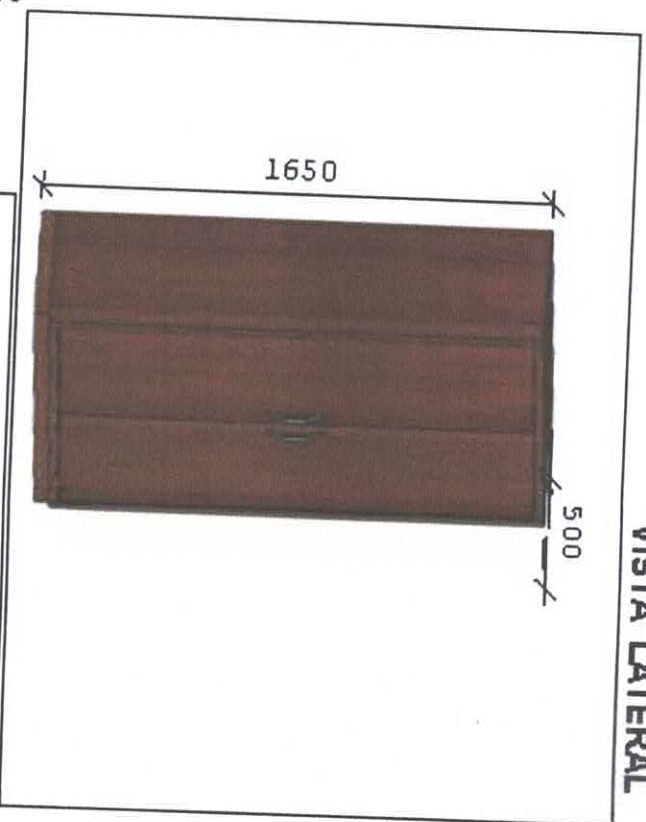

INFORMAÇÕES

Mdf 15mm itauba  
tamponamento engrossado 30mm  
Mdf interno branco Tx  
Puxador haste  
c/ sapatilhas

MARCCENARIA

Projetista: Vanessa Machado

PROJETO: ARMÁRIO

CLIENTE: F M de Educacao do  
Município de Sao Valerio

CNPJ: 31.237.827/0001-47



Documento assinado digitalmente  
VANESSA TATIANE PEREIRA MACHADO  
Data: 08/07/2024 11:56:02-0300  
Verifique em <https://validar.jbr.gov.br/>

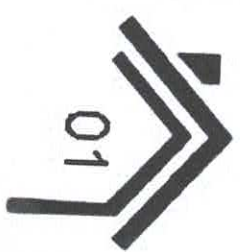



Mesa KRONNA SALA DIRETORIA

VISTA FRONTAL

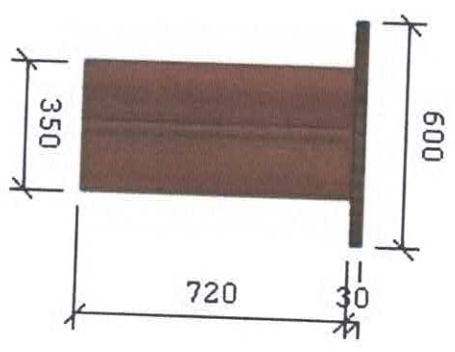

VISTA LATERAL

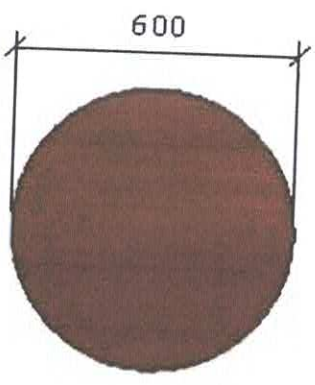

VISTA SUPERIOR

**INFORMAÇÕES**  
Mdf 15mm Itauba  
tampo engrossado 30mm  
c/ sapatilhas

**MARCENARIA**

Documento assinado digitalmente  
**VANESSA TATIANE PEREIRA MACHADO**  
Data: 08/07/2024 13:24:11 -0300  
Verifique em <https://validar.it.gov.br>



Projetista: Vanessa Machado

PROJETO: MESA DE CANTO

CLIENTE: F M de Educacao do  
Município de Sao Valerio

CNPJ: 31.237.827/0001-47

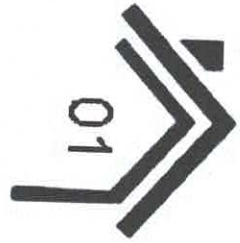



11 BARRA PL AUDITÓRIO

VISTA FRONTAL

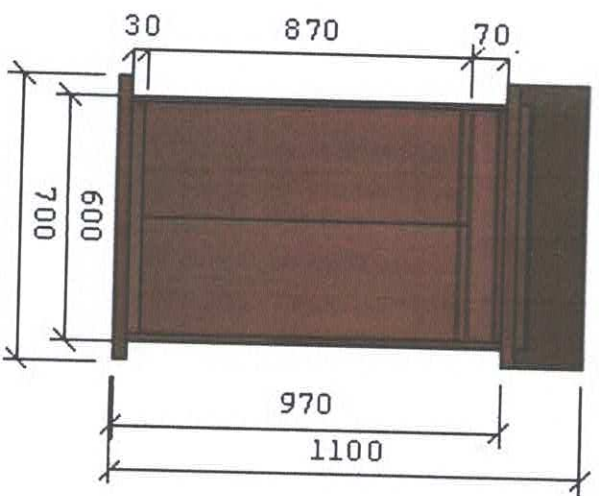

VISTA LATERAL

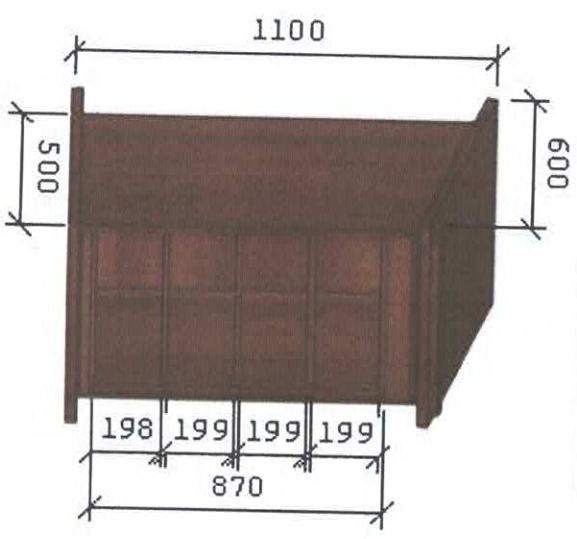

VISTA SUPERIOR

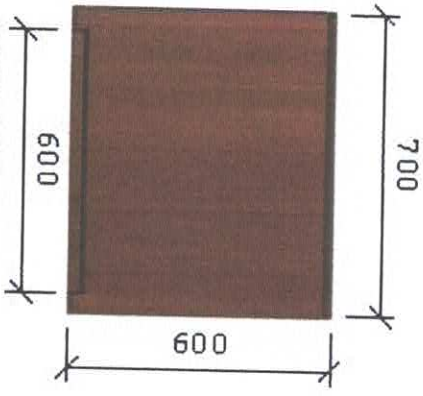

**INFORMAÇÕES**  
Mdf 15mm Itauba  
tampornamento engrossado 30mm  
c/ sapatilhas

Documentos assinado digitalmente  
**gov.br**  
VANESSA TATIANE PEREIRA MACHADO  
Data: 08/07/2024 13:24:11 -0300  
Verifique em: <https://validar.rti.gov.br>

**MARCENARIA**

Projetista: Vanessa Machado

PROJETO: PÚLPITO

CLIENTE: F M de Educacao do  
Município de Sao Valerio

CNPJ: 31.237.827/0001-47

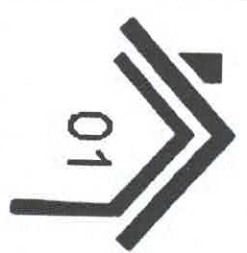



Mesa (P) Auditório

**VISTA FRONTAL**

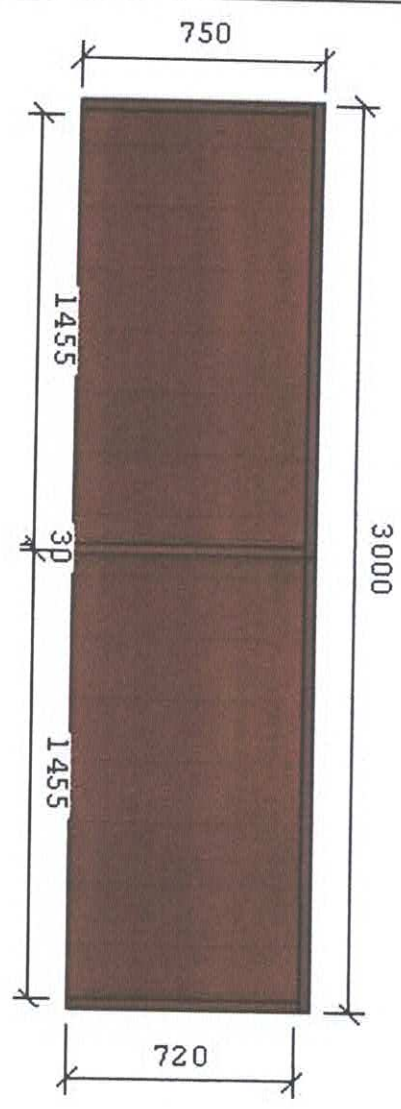

**VISTA LATERAL**

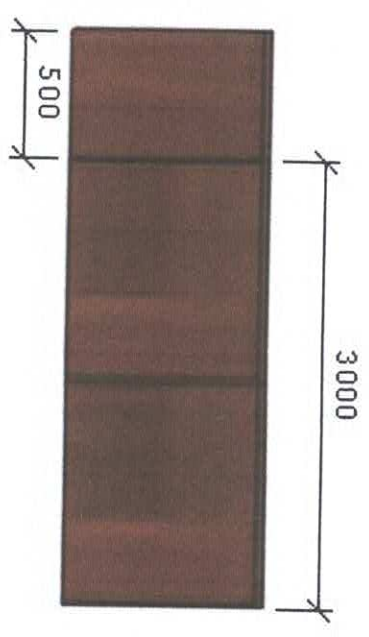

**VISTA SUPERIOR**

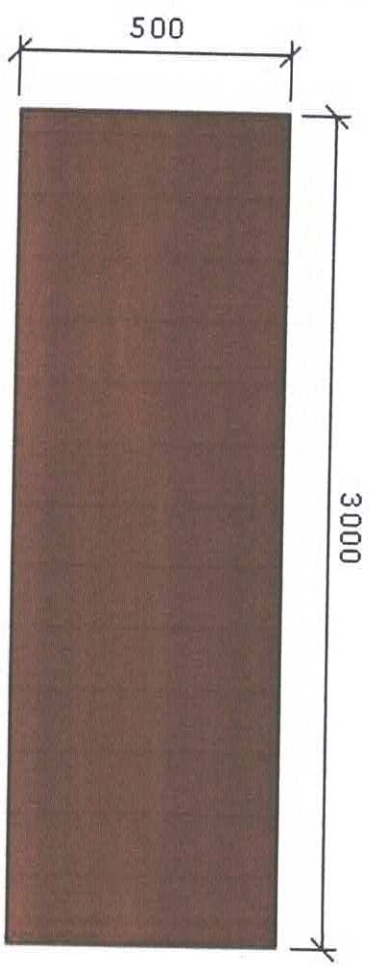

**INFORMAÇÕES**  
Mdf 15mm/tauba  
tamponamento engrassado 30mm  
c/ sapatilhas

**MARCENARIA**

Projetista: Vanessa Machado

PROJETO: MESAS DE TRABALHO

CLIENTE: F.M. de Educacao do  
Município de Sao Valerio

CNPJ: 31.237.827/0001-47

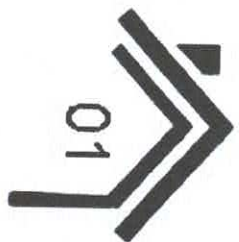

Documento assinado digitalmente  
VANESSA TATIANE PEREIRA MACHADO  
Data: 08/07/2024 13:24:11 -0300  
Verifique em <https://validar.rtf.gov.br>



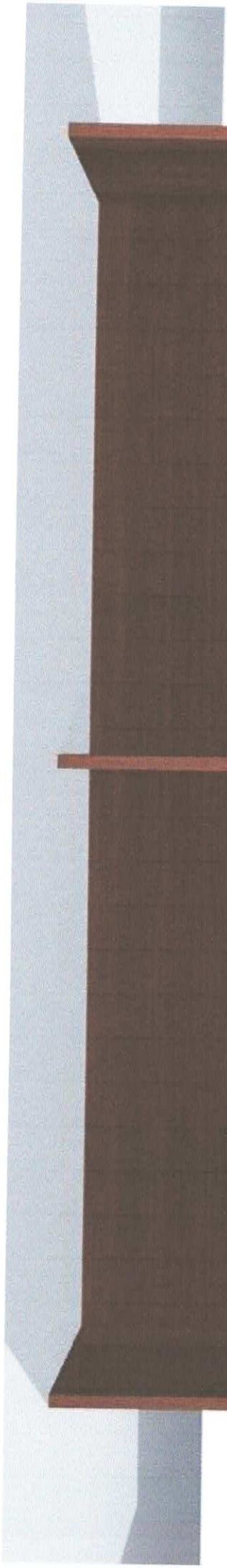



### VISTA FRONTAL ABERTO

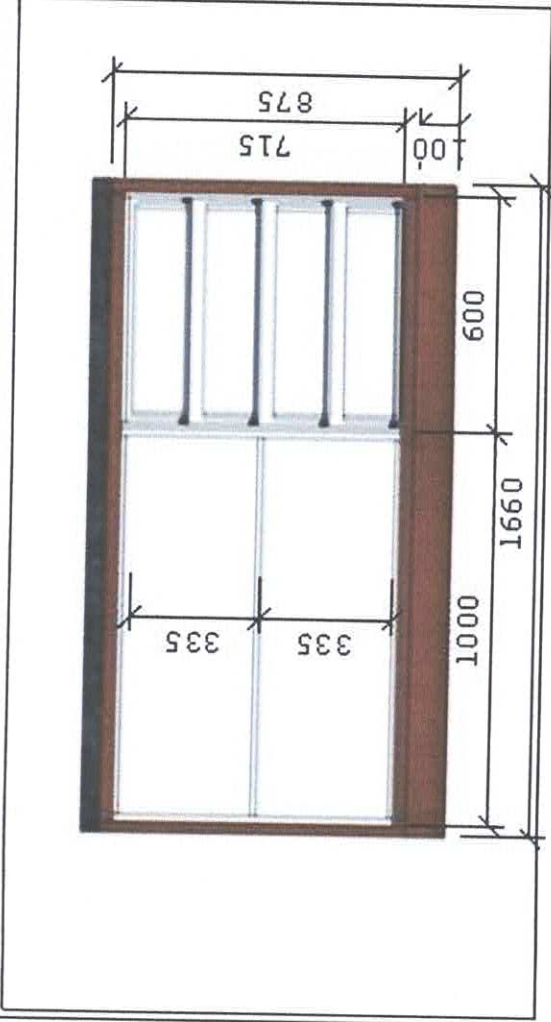

### VISTA LATERAL

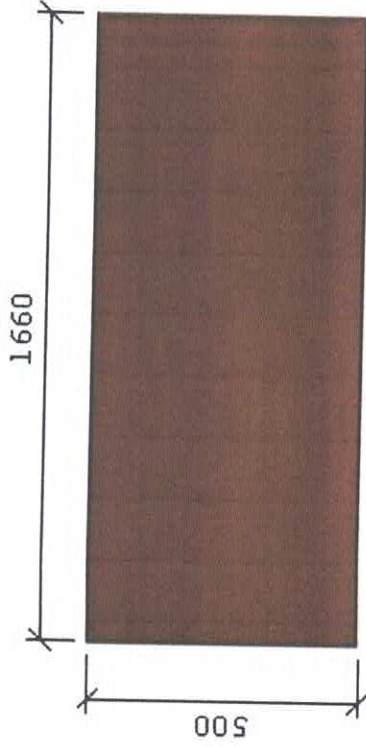
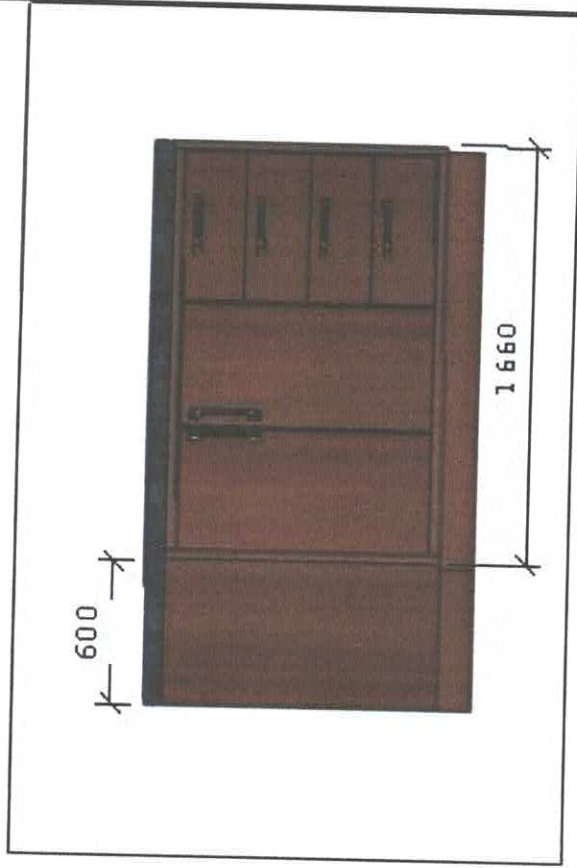

### VISTA SUPERIOR

**INFORMAÇÕES**  
Mdf 15mm Itauba  
tamponamento engrossado 30mm  
Mdf interno branco Tx  
Puxador Haste  
cf sapatilhas  
Corrediças telescópicas

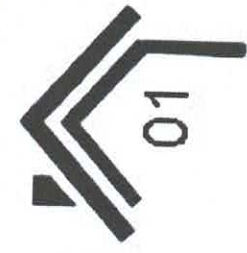

PROJETO: ARMÁRIO DE COZINHA

CLIENTE: F M de Educacao do  
Município de Sao Valerio

CNPJ: 31.237.827/0001-47

**MARCCNARIA**

Projetista: Vanessa Machado

Documento assinado digitalmente  
VANESSA TATIANE PEREIRA MACHADO  
Data: 09/07/2024 13:21:07-0300  
Verifique em <https://validar.iti.gov.br>





Mesa Computador Sala dos Professores

### VISTA FRONTAL ABERTO

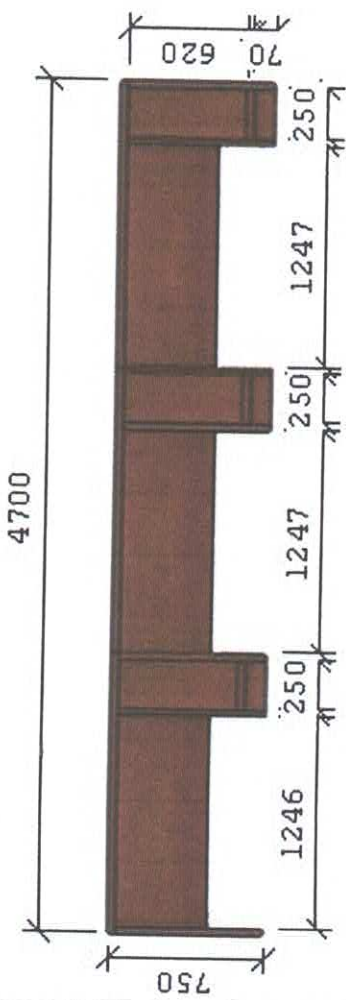

### VISTA SUPERIOR

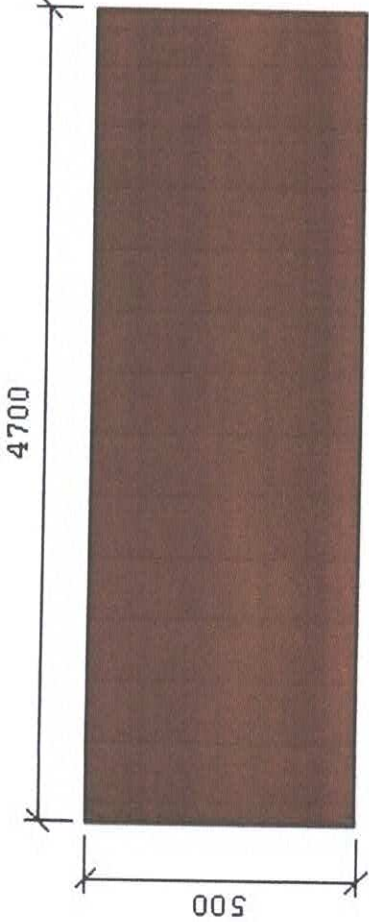

### INFORMAÇÕES

Mdf 15mm Itauba  
tamponamento engrossado 30mm  
c/ sapatilhas

### VISTA LATERAL

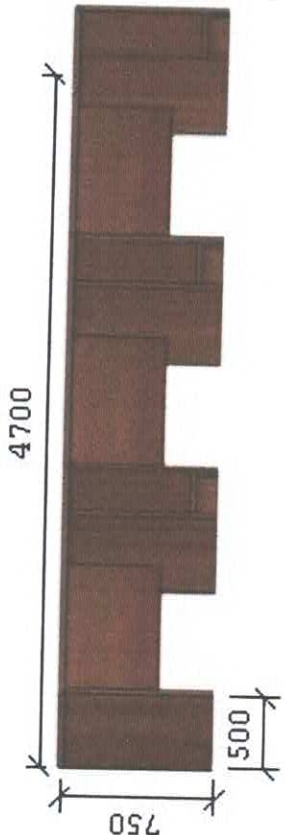

gov.br  
Documento assinado digitalmente  
VANESSA TATIANE PEREIRA MACHADO  
Data: 08/07/2024 13:21:07-0300  
Verifique em <https://validar.rib.gov.br>

**MARCENARIA**

Projetista: Vanessa Machado

PROJETO: ESTAÇÃO DE TRABALHO

CLIENTE: F M de Educacao do  
Município de Sao Valerio

CNPJ: 31.237.827/0001-47

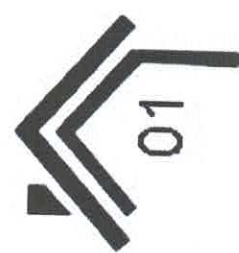

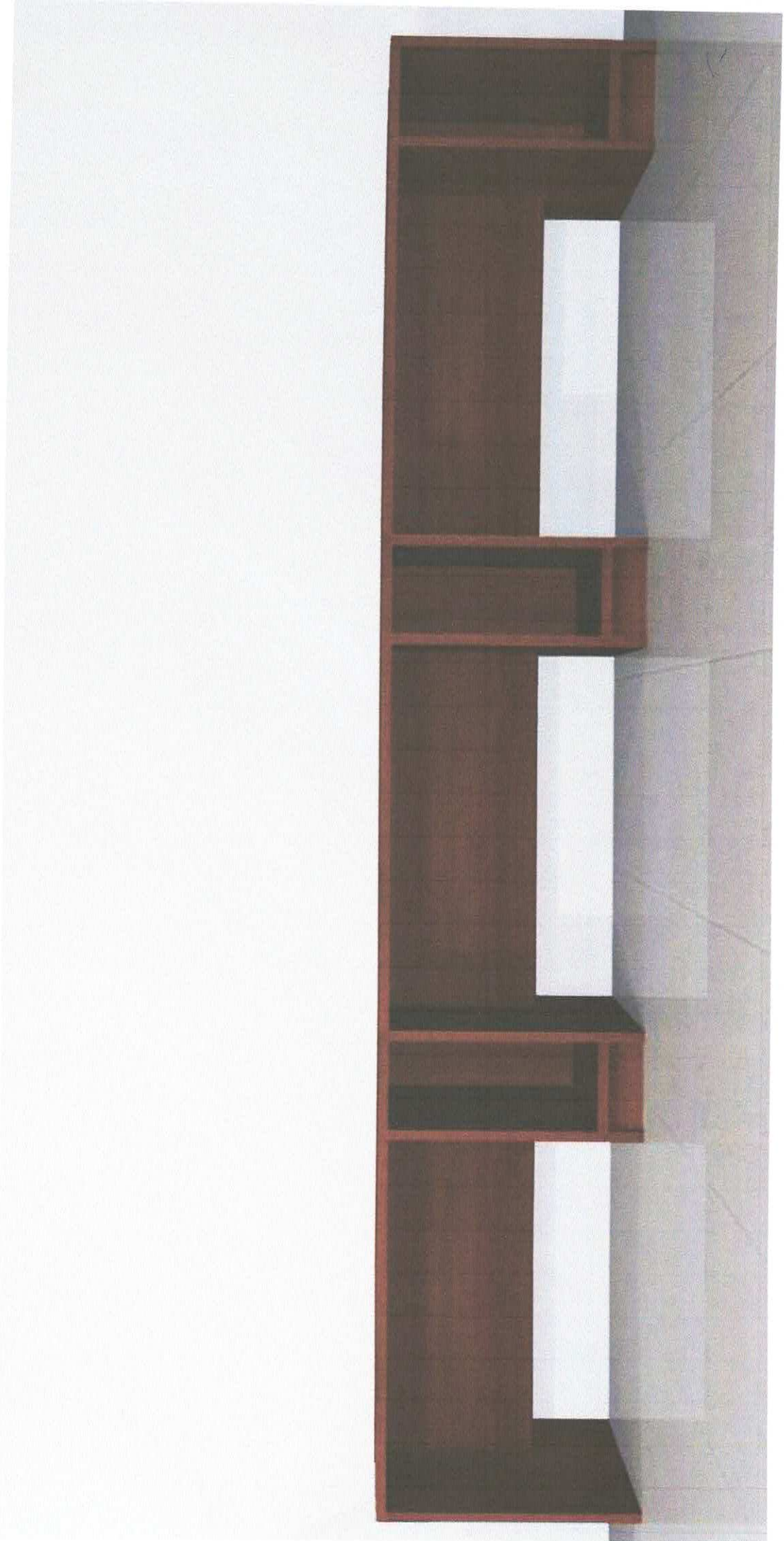

Mesa TI Computador Cobr Den Ação

### VISTA FRONTAL

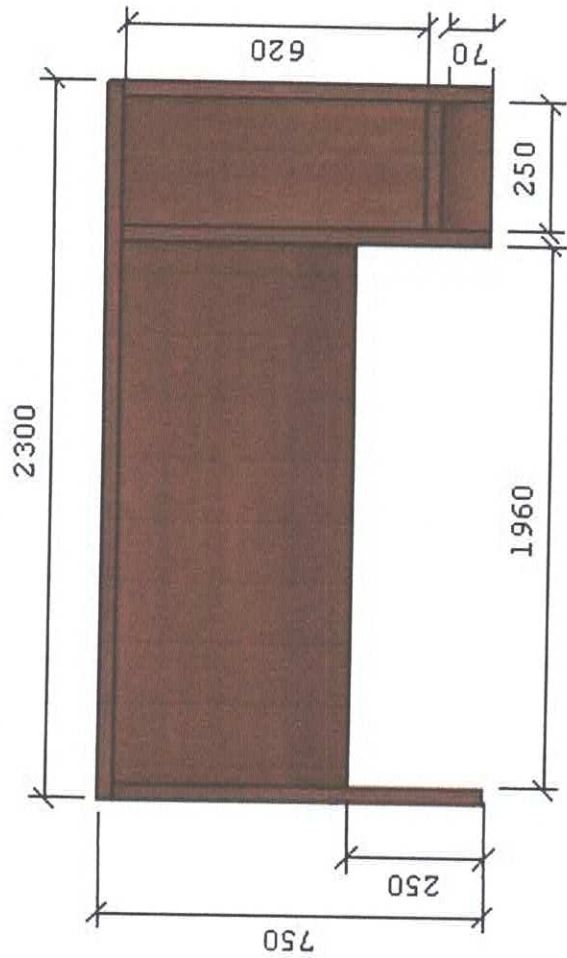

### VISTA LATERAL

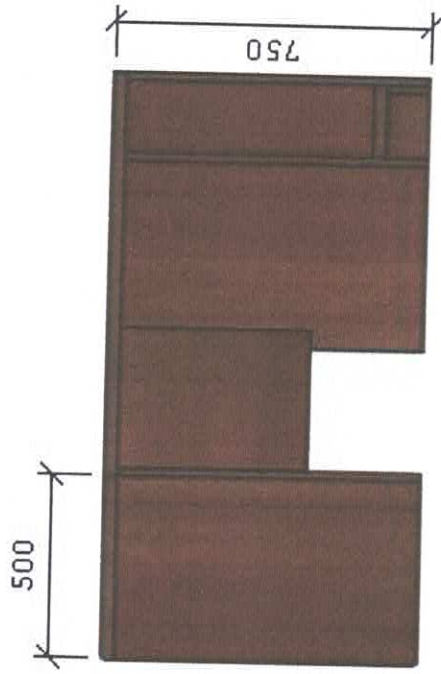

### VISTA SUPERIOR

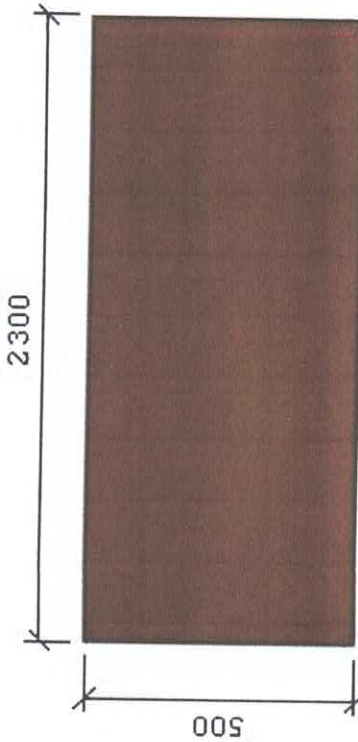

### INFORMAÇÕES

Mdf 15mm Itauba  
tamponamento engrossado 30mm  
c/ sapatilhas

Documento assinado digitalmente  
**gov.br**  
VANESSA TATIANE PEREIRA MACHADO  
Data: 08/07/2024 13:21:07-0300  
Verifique em <https://validar.itb.gov.br>

**MARCENARIA**

Projetista: Vanessa Machado

PROJETO: MESA G. DE TRABALHO

CLIENTE: F M de Educacao do  
Municipio de Sao Valerio

CNPJ: 31.237.827/0001-47

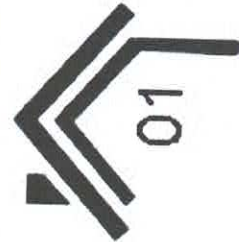

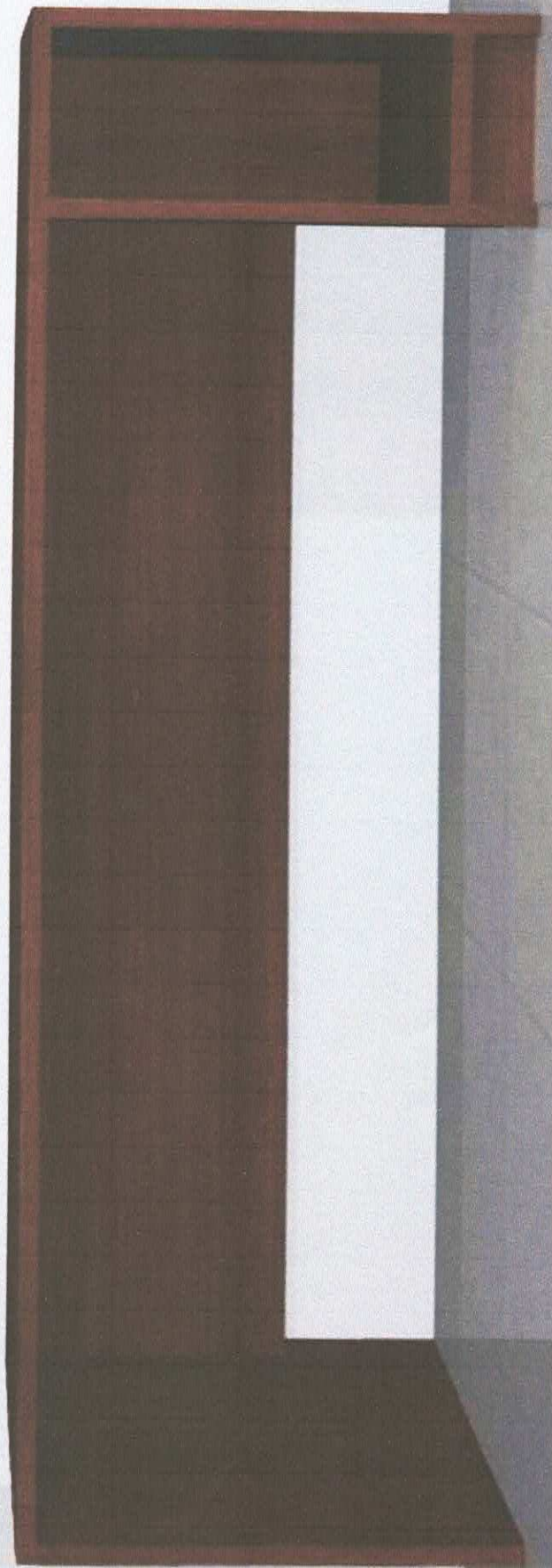

Mesa P/ Computador Onde nasce

### VISTA FRONTAL

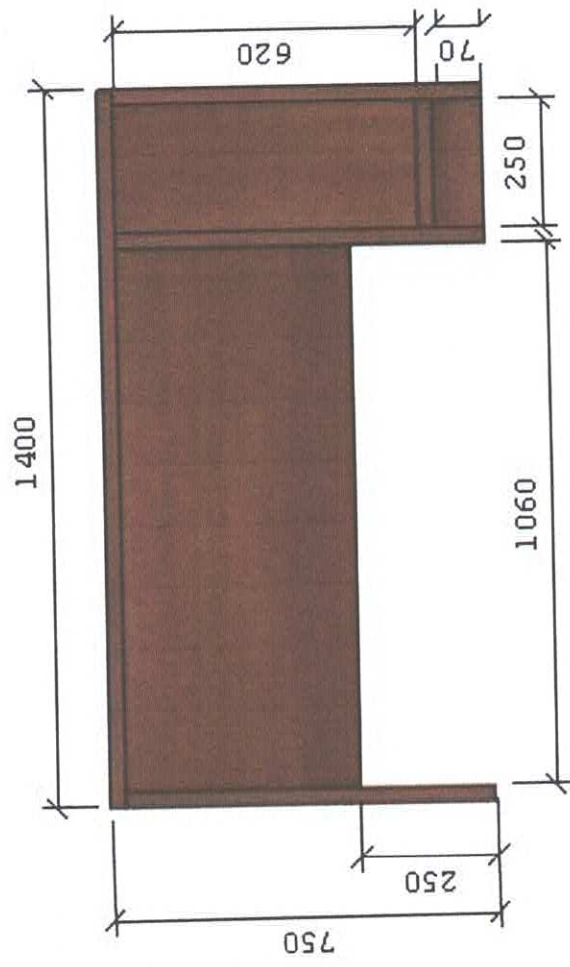

### VISTA LATERAL

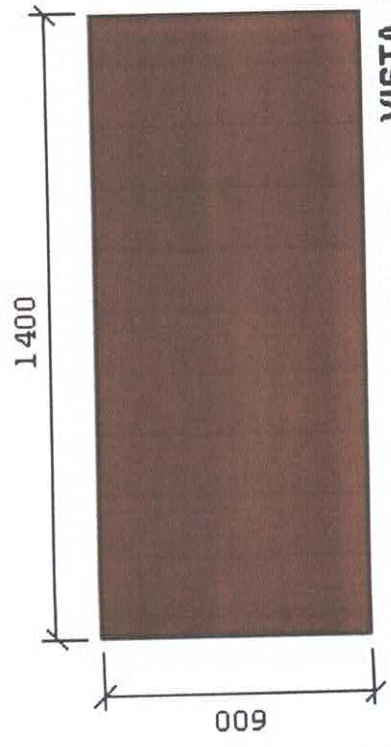
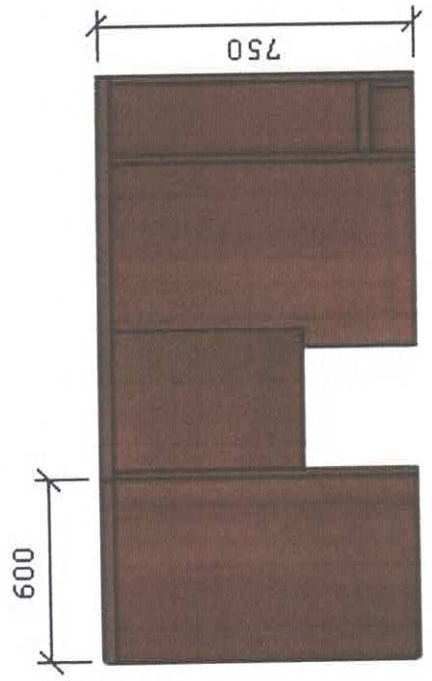

### VISTA SUPERIOR

**INFORMAÇÕES**  
Mdf 15mm Itauba  
tamponamento engrossado 30mm  
c/ sapatilhas

Documento assinado digitalmente  
**gov.br**  
VANESSA TATIANE PEREIRA MACHADO  
Data: 08/07/2024 13:21:07-0300  
Verifique em <https://validar.itb.gov.br>

**MARCENTARIA**

Projetista: Vanessa Machado

PROJETO: MESA DE TRABALHO

CLIENTE: F M de Educacao do  
Municipio de Sao Valerio

CNPJ: 31.237.827/0001-47



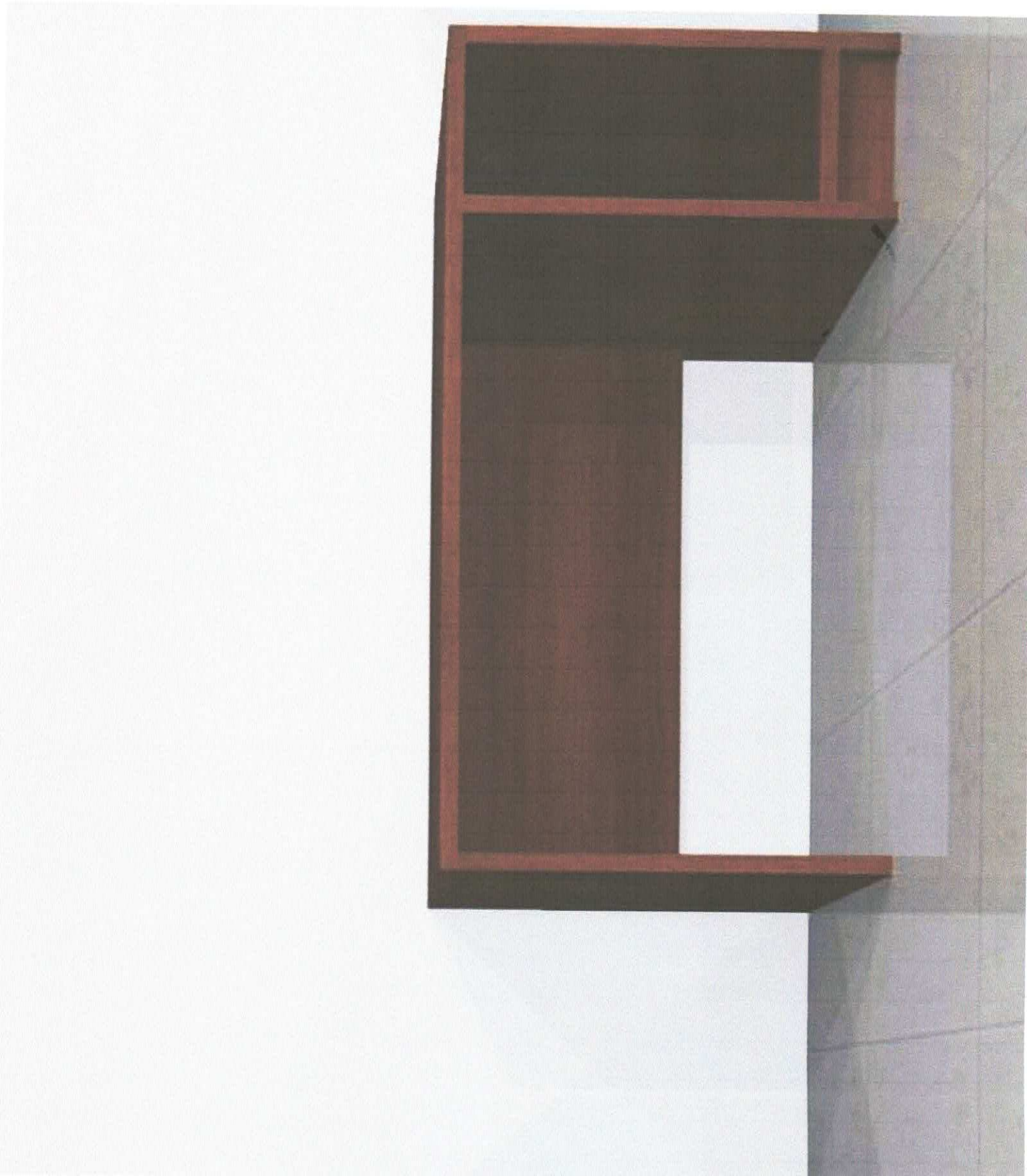



ESTAÇÃO DE TRABALHO SECRETARIA

### VISTA FRONTAL ABERTO

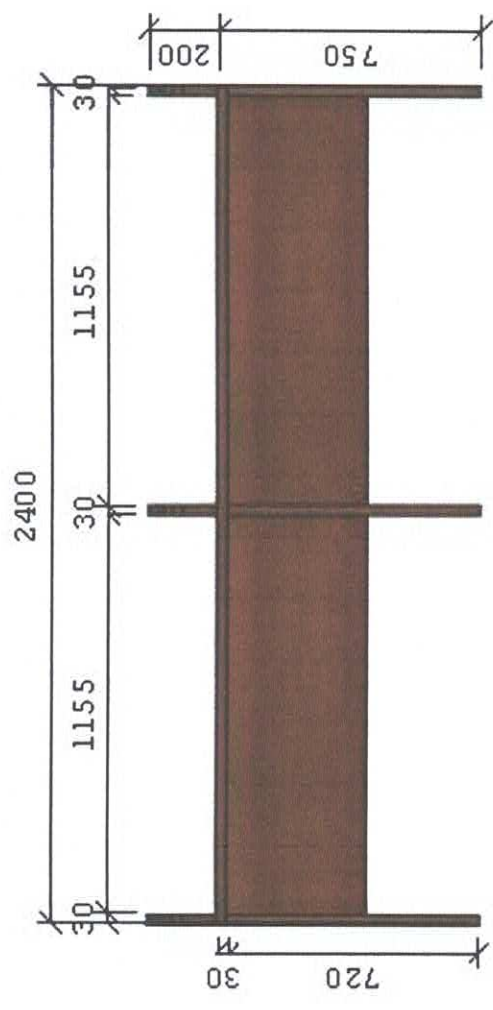

### VISTA LATERAL

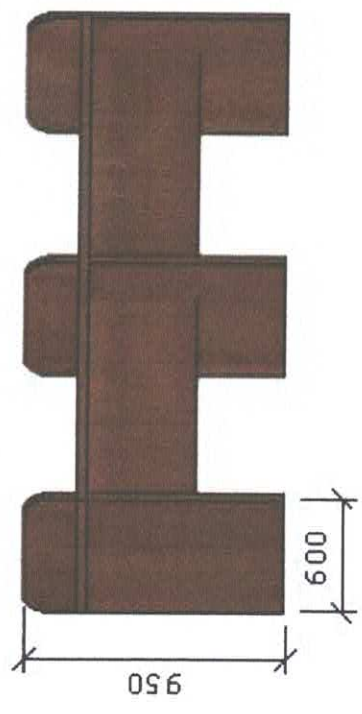

### INFORMAÇÕES

Mdf 15mm itauba  
tamponamento engrossado 30mm  
c/ sapatilhas

### VISTA SUPERIOR

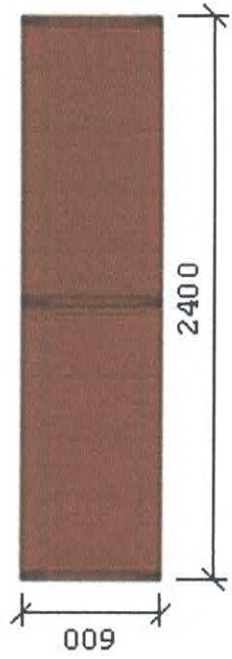

PROJETO: ESTAÇÃO DE TRABALHO

CLIENTE: F M de Educacao do  
Município de Sao Valerio

CNPJ: 31.237.827/0001-47

**MARCENARIA**

Projetista: Vanessa Machado

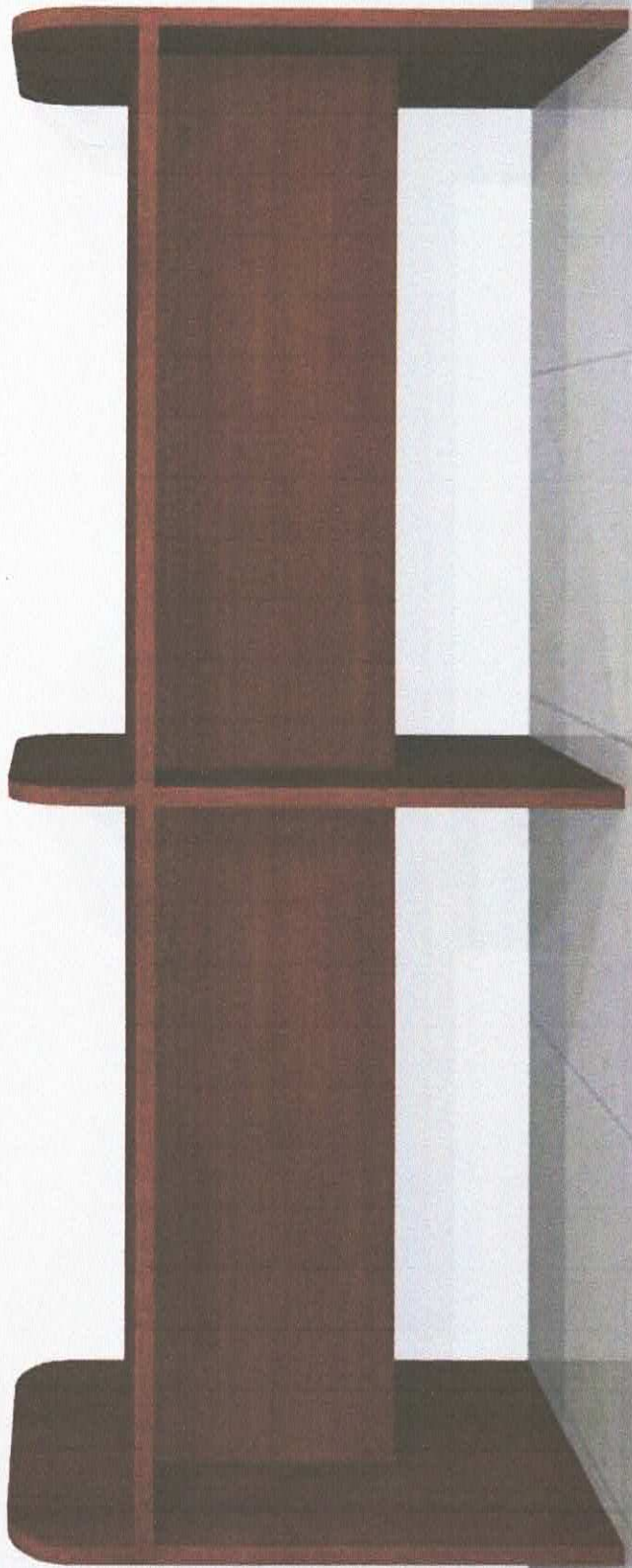

Guarda volumes sala dos professores

### VISTA FRONTAL ABERTO

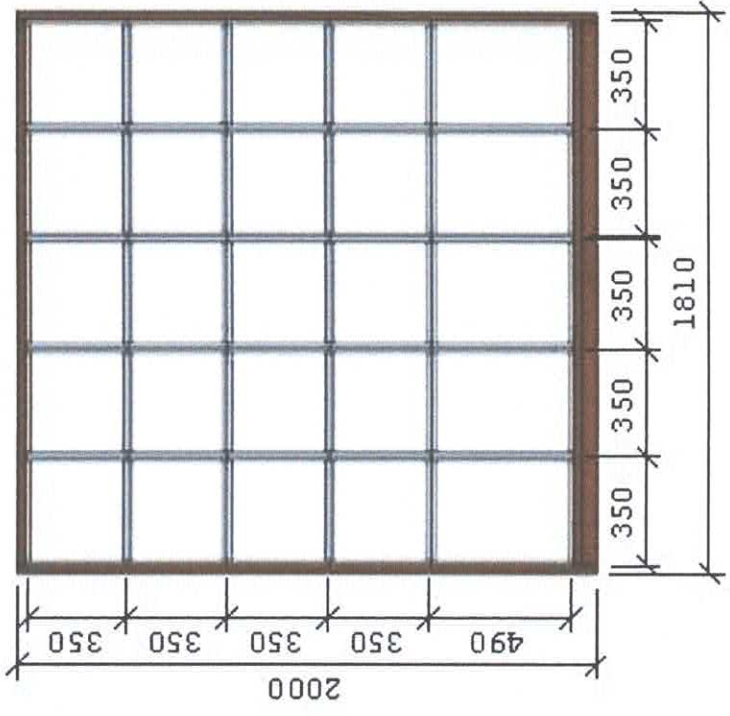

### VISTA SUPERIOR

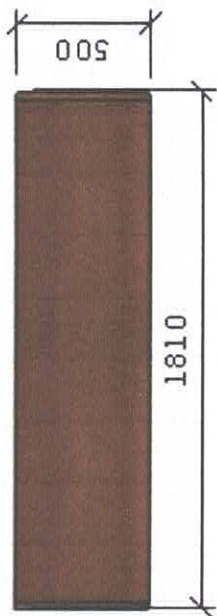

### VISTA LATERAL

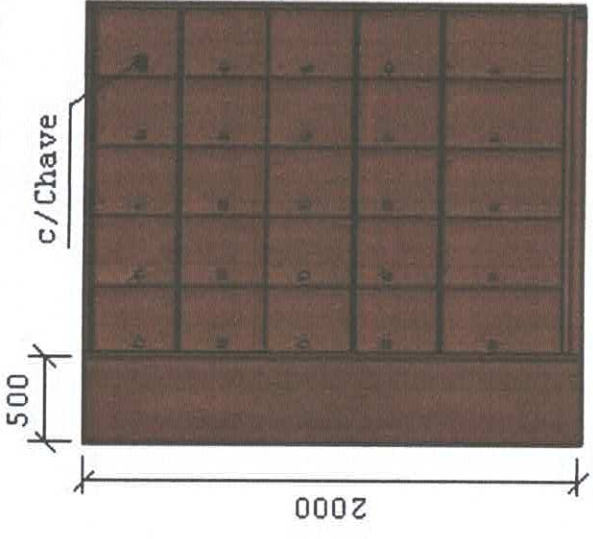

#### INFORMAÇÕES

Mdf 15mm Itauba  
tamponamento engrossado 30mm  
Mdf interno branco Tx  
c/ sapatilhas  
c/ chave

### MARCCENARIA

Projetista: Vanessa Machado

PROJETO: GUARDA VOLUME

CLIENTE: F M de Educacao do  
Municipio de Sao Valerio

CNPJ: 31.237.827/0001-47

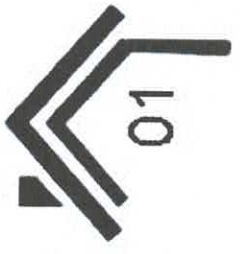

Documento assinado digitalmente:  
**VANESSA TATIANE PEREIRA MACHADO**  
Data: 08/07/2024 11:56:02-0300  
Verifique em <https://validar.rti.gov.br>



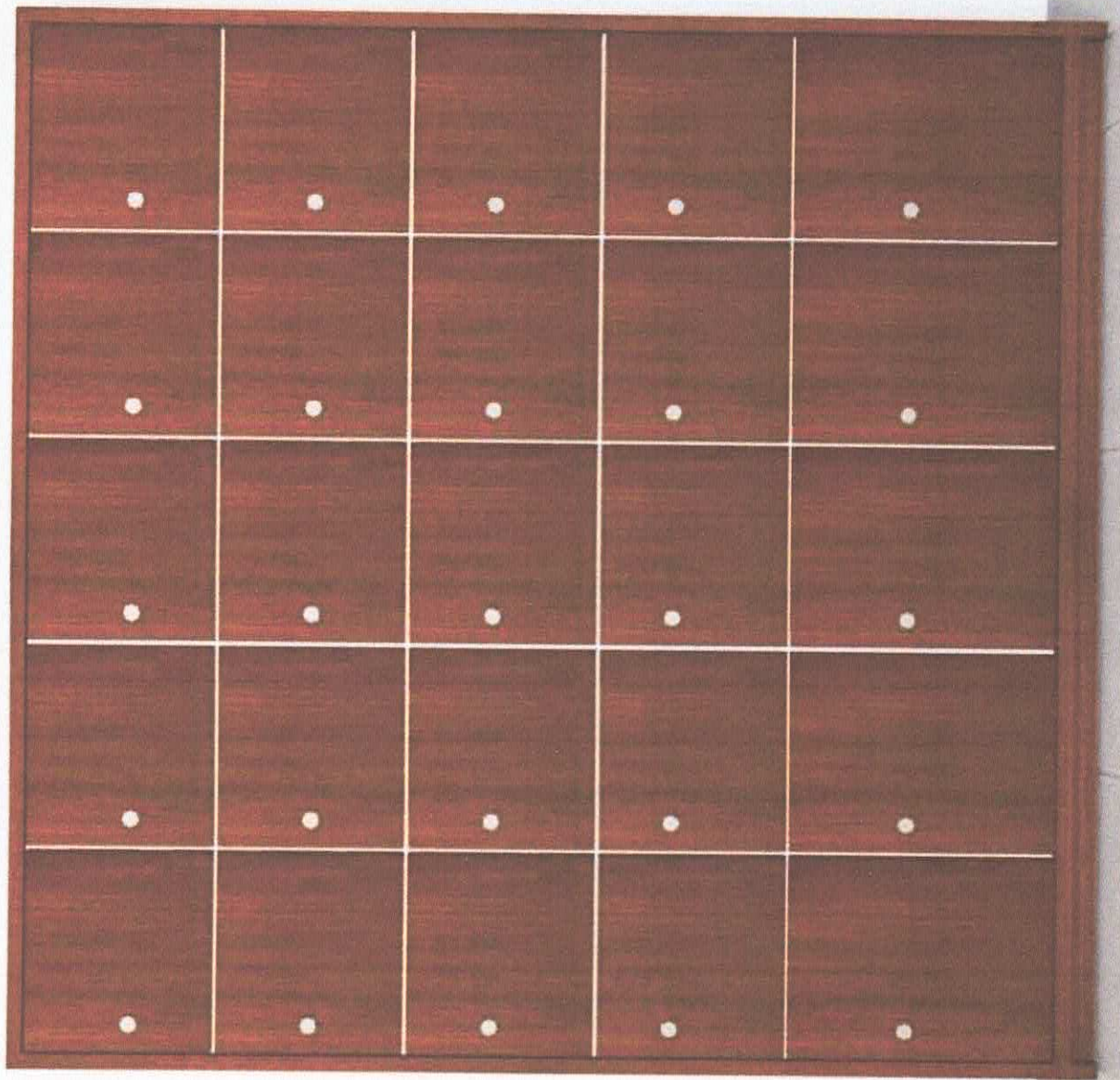

ARMARIO 9/ SALAS DE AULA

VISTA FRONTAL ABERTO

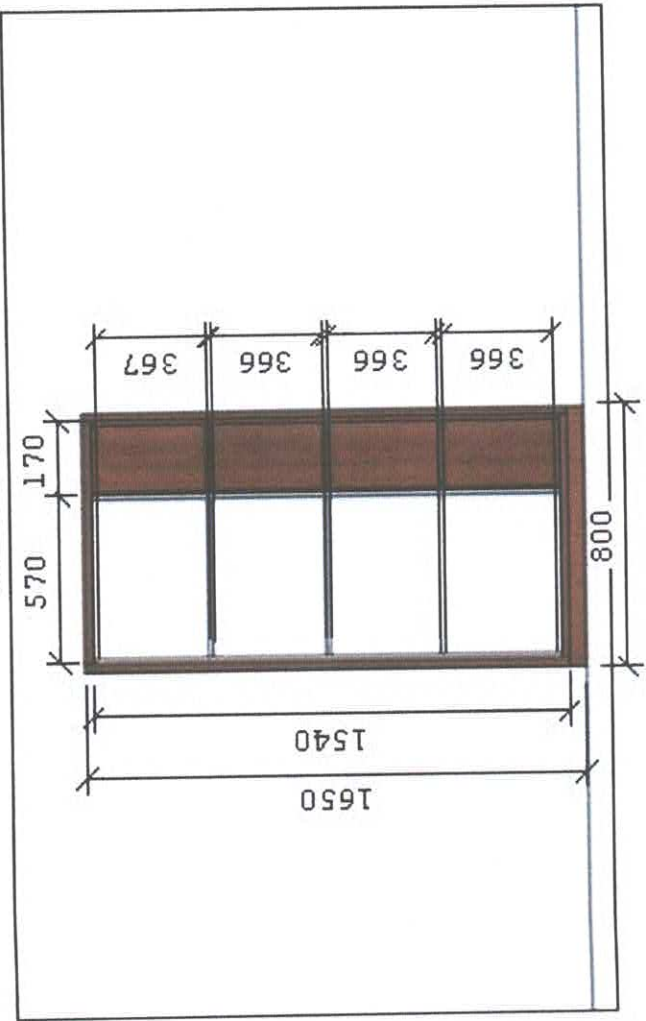

VISTA LATERAL

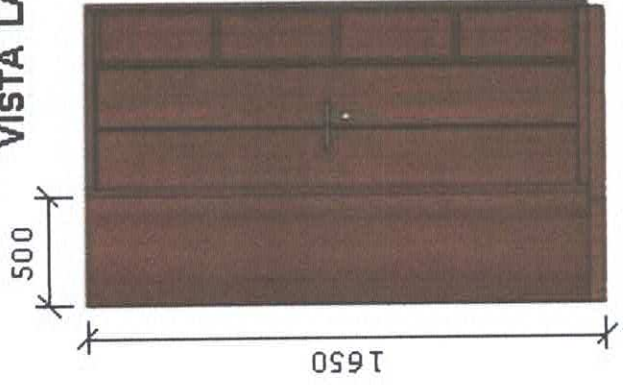

INFORMAÇÕES

Mdf 15mm Itauba  
tamponamento engrossado 30mm  
Mdf interno branco Tx  
Puxador haste  
c/ sapatilhas  
c/ chave

VISTA SUPERIOR

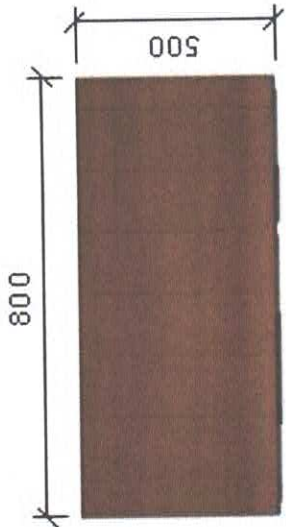

MARCCENARIA

Projetista: Vanessa Machado



PROJETO: ARMÁRIO C/ NICHOS

CLIENTE: F M de Educacao do  
Município de Sao Valerio

CNPJ: 31.237.827/0001-47

Documento assinado digitalmente  
VANESSA TATIANE PEREIRA MACHADO  
Data: 08/07/2024 11:56:02-0300  
Verifique em <https://validar.it.gov.br>



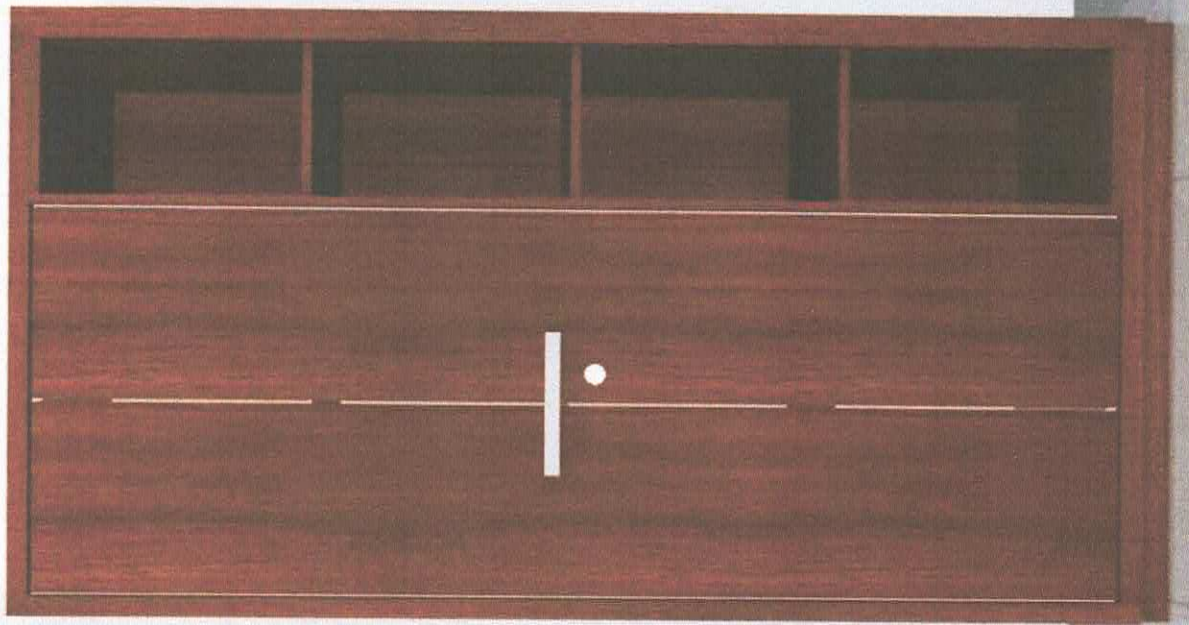

ARMARIO SALA DI RETORA

**VISTA FRONTAL ABERTO**

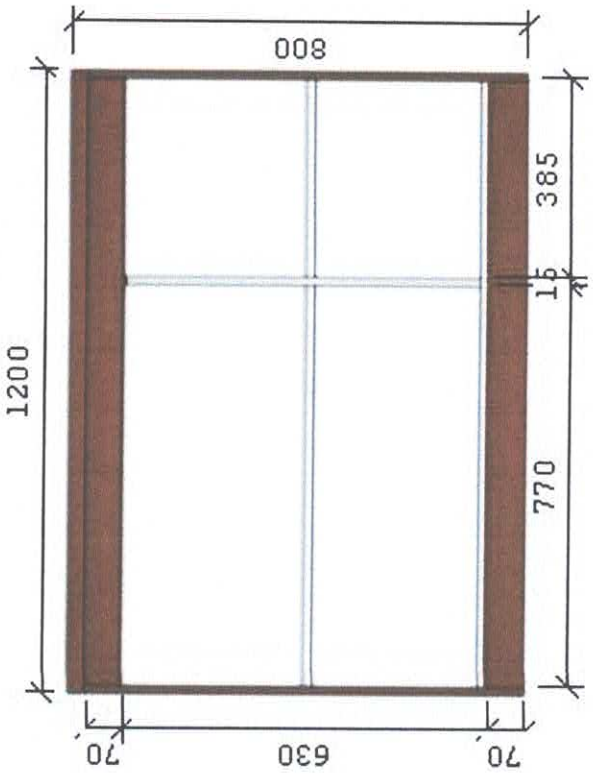

**VISTA LATERAL**

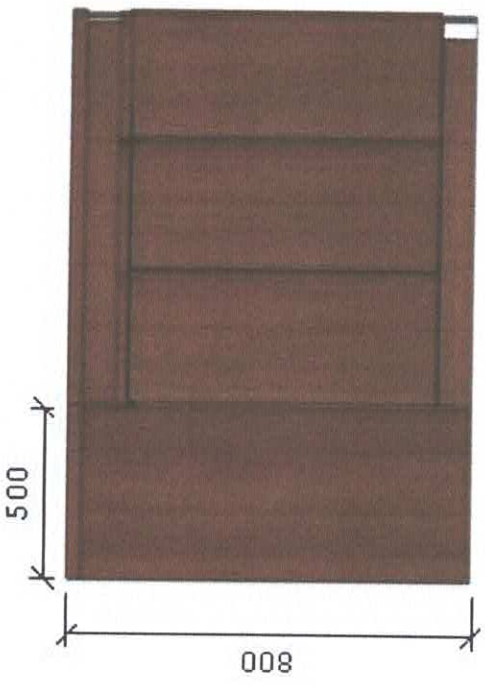

**VISTA SUPERIOR**

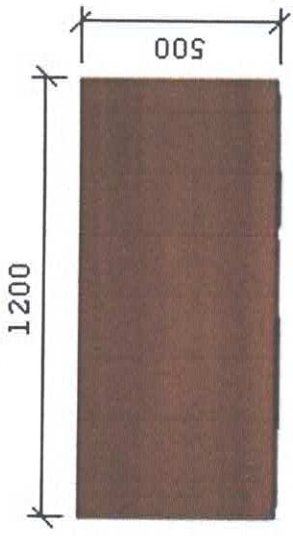

**INFORMAÇÕES**

Mdf 15mm Itauba  
tamponamento engrossado 30mm  
Mdf interno branco Tx  
Puxador no mdf  
c/ sapatilhas

Documento assinado digitalmente  
**gov.br**  
VANESSA TATIANE PEREIRA MACHADO  
Data: 08/07/2024 11:56:02-0300  
Verifique em <https://validar.itl.gov.br>

**MARCCNARIA**

Projetista: Vanessa Machado

PROJETO: ARMÁRIO BUFFET

CLIENTE: F M de Educacao do  
Municipio de Sao Valerio

CNPJ: 31.237.827/0001-47



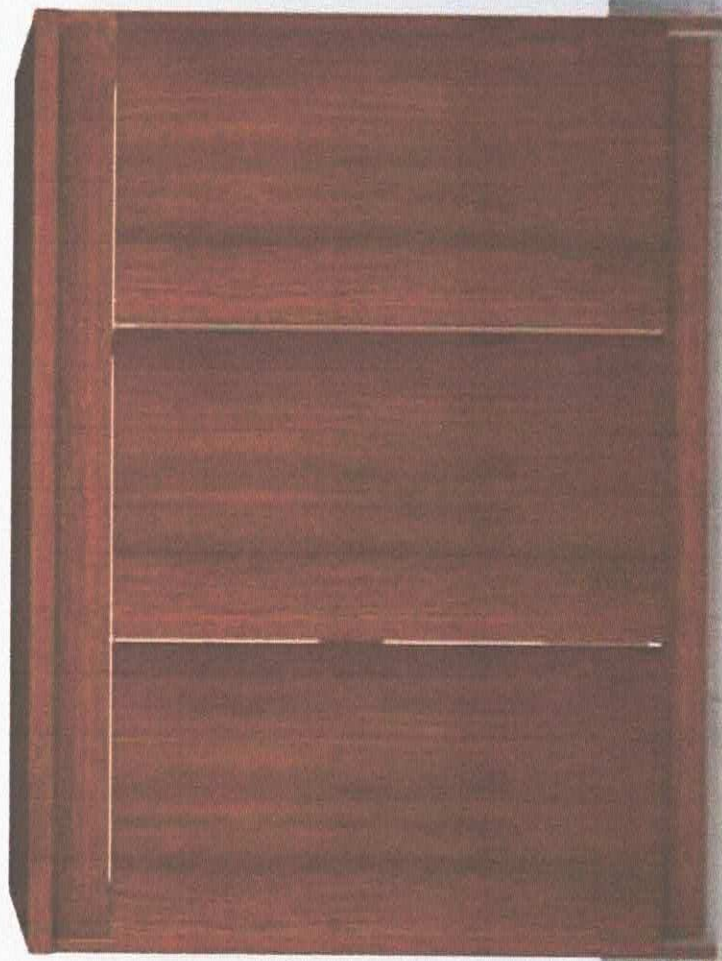



# Aparador SALA DIRETORA - PROFESSORES

